

DOCUMENTACIÓN TÉCNICA



Ref.: PISO01

Panel informativo
"Vaquero"

EN-UNE 1176-1:2018

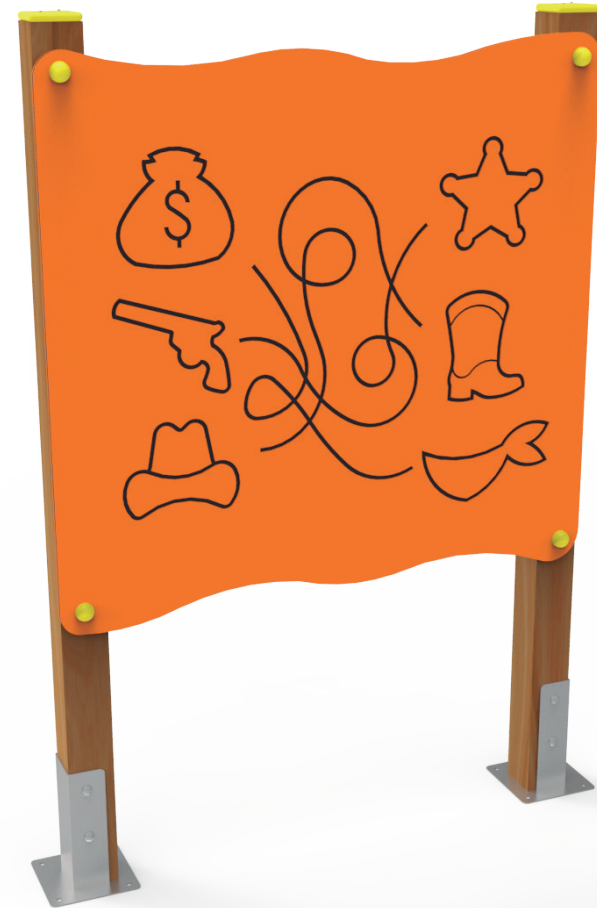
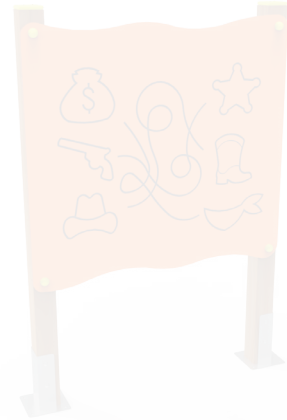

Componentes de acero carbono
Tratamiento galvanizado y pintado al horno
Tornillería protegida con tapones de polipropileno

ALZADO

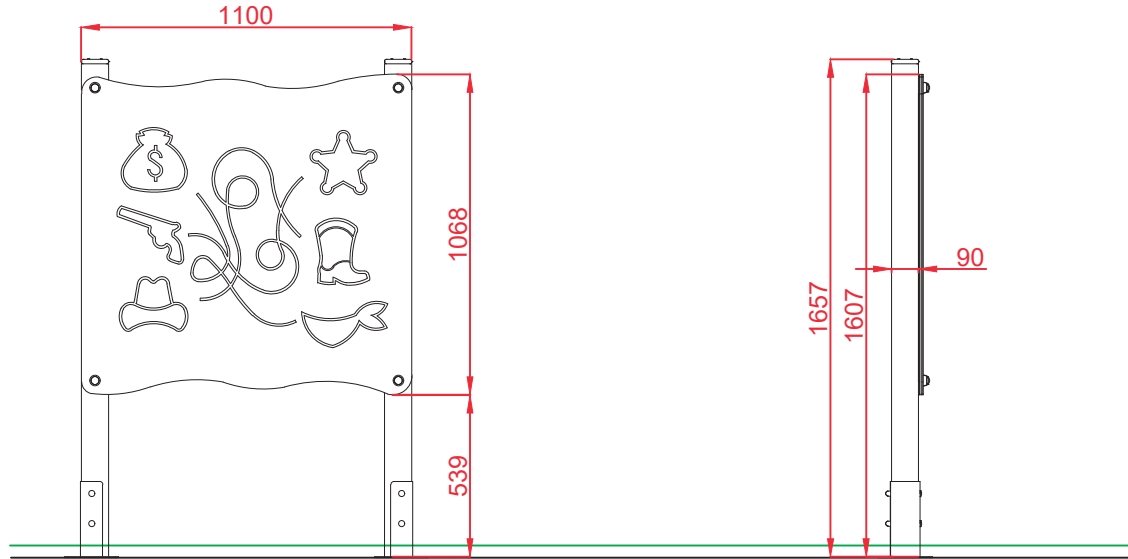

PERFIL

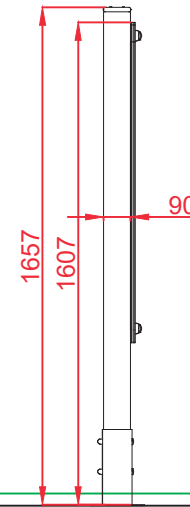

PLANTA

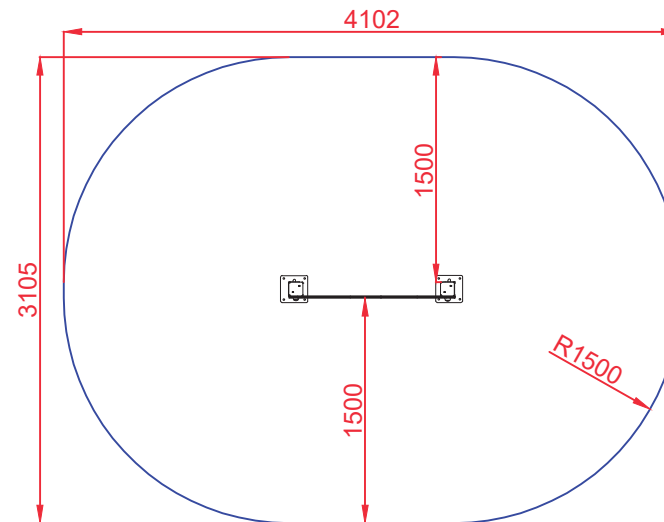

ÁREA DE SEGURIDAD
Superficie= 10,81 m2
E: 1/2

Dibujado		PLANO 1 VISTAS GENERALES	Ref:	PISO01
Revisado				
Aprobado				
Descripción:		Escala:	Hoja:	
PANEL INFORMATIVO "VAQUERO"		Fecha:	30/09/2019	

DETALLES CIMENTACIÓN

ESQUEMA DE CIMENTACIÓN EN ARENA

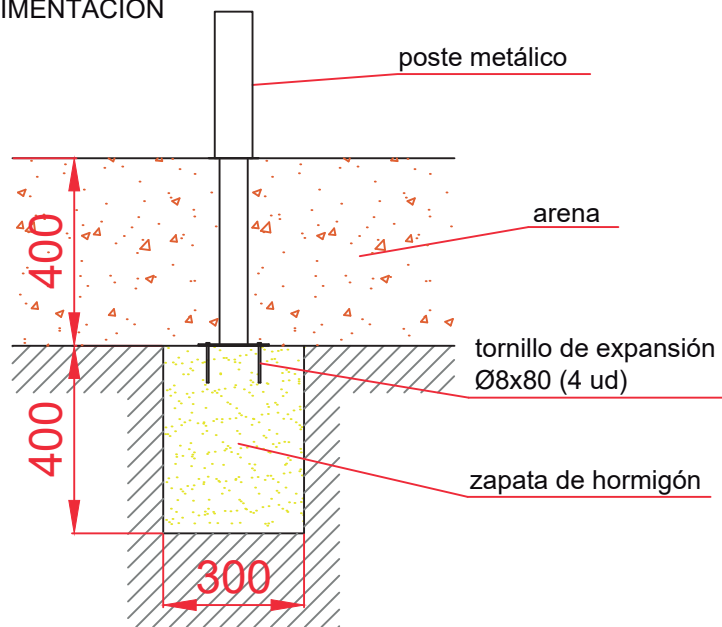

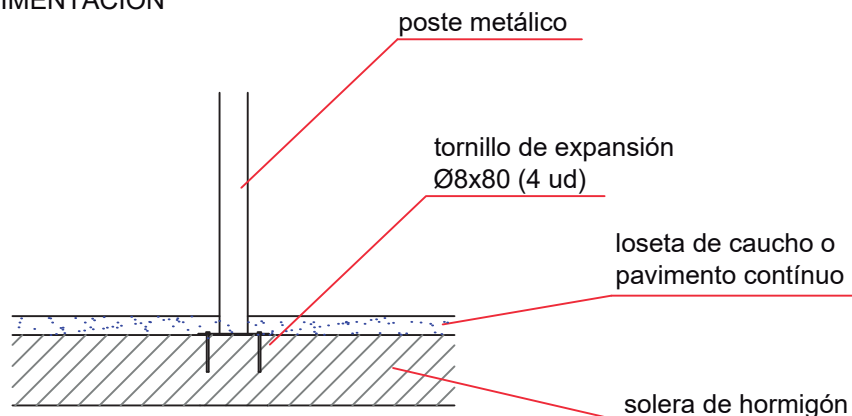

ESQUEMA DE CIMENTACIÓN EN HORMIGÓN

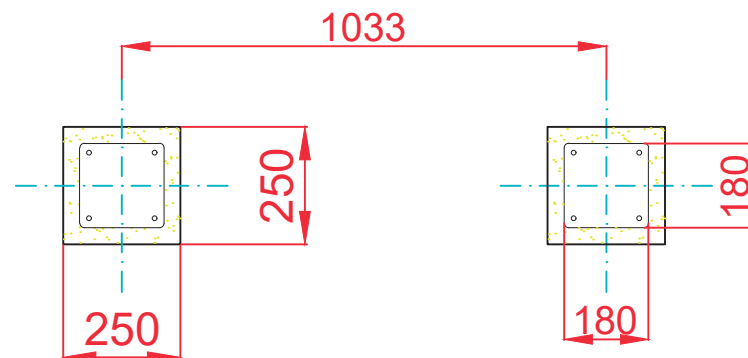

DETALLE DE ANCLAJE

PLANTA DE CIMENTACIÓN



Dibujado		PLANO 2 CIMENTACIÓN	Ref:	PISO01
Revisado				
Aprobado				
Descripción:		Escala:	Hoja:	3/3
PANEL INFORMATIVO "VAQUERO"		Fecha:	30/09/2019	