

# DOCUMENTACIÓN TÉCNICA

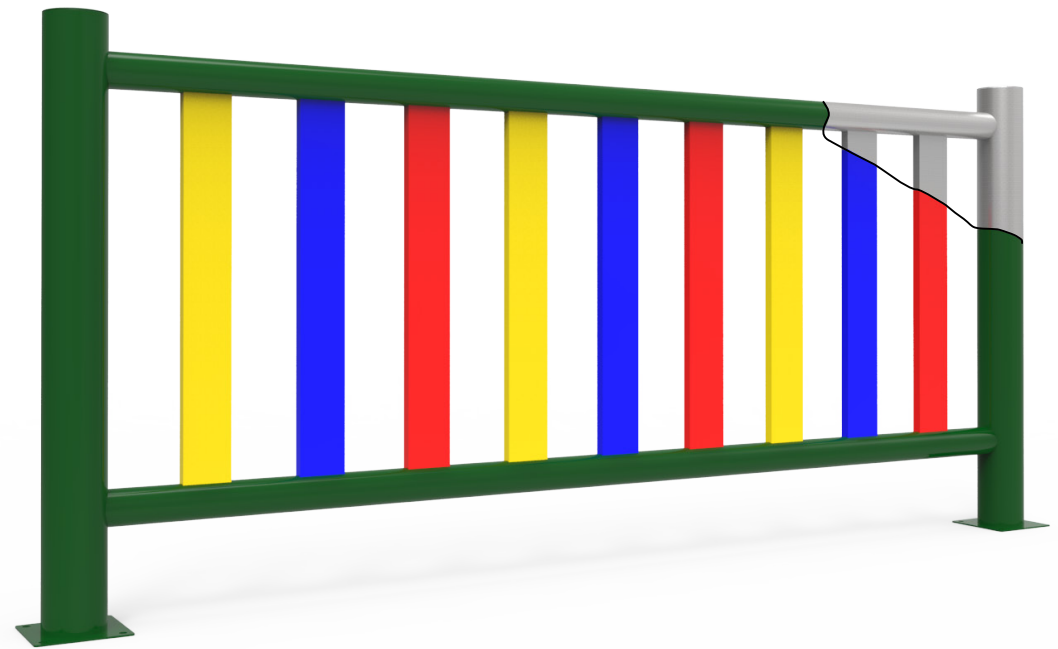
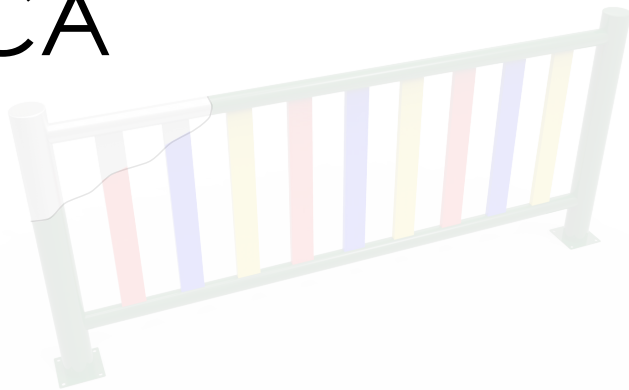

Ref.: VLL02-G

Valla Metálica Galvanizada  
y Lacada

UNE EN 1176-1:2018



Estructura metálica de acero galvanizado  
Tratamiento termolacado

ALZADO

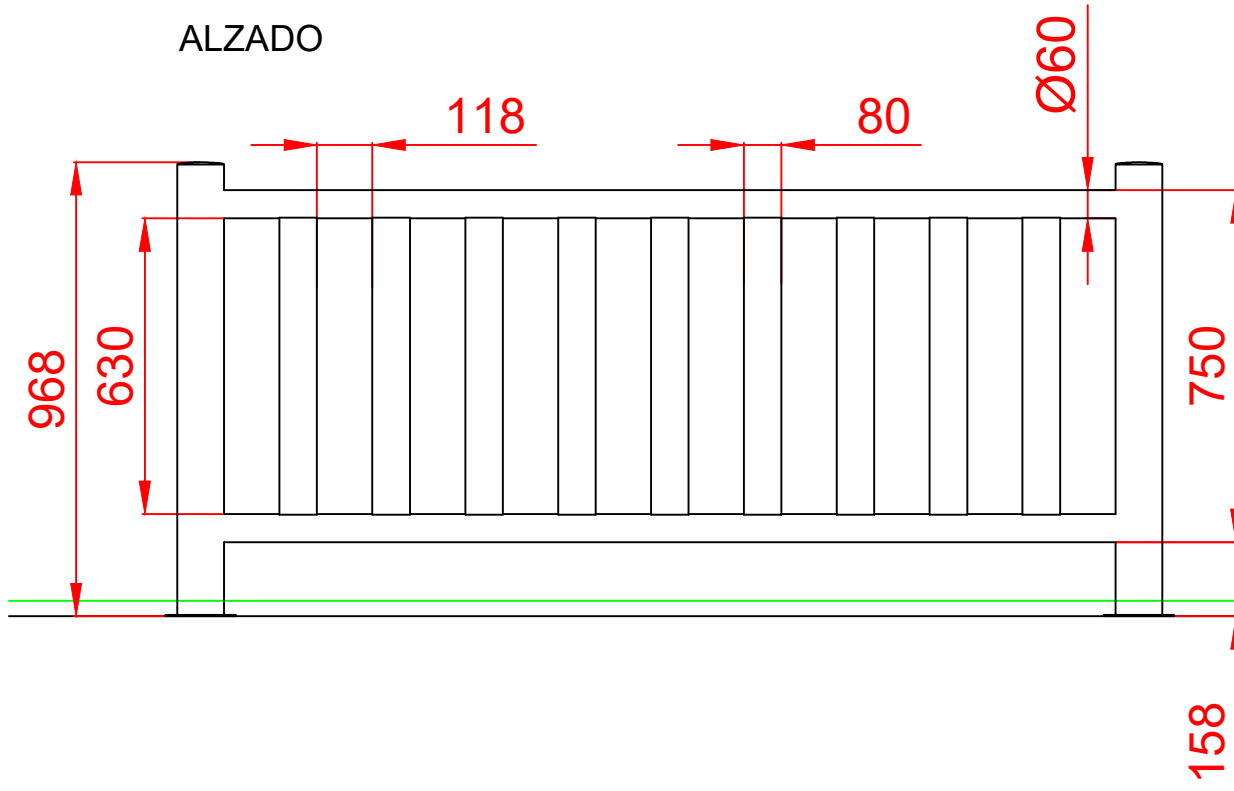

PERFIL IZQUIERDO

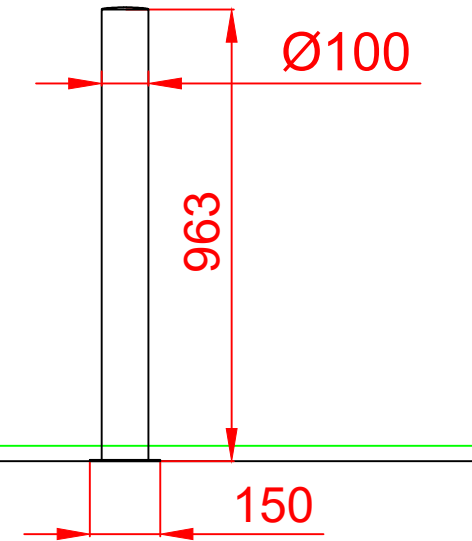

PLANTA

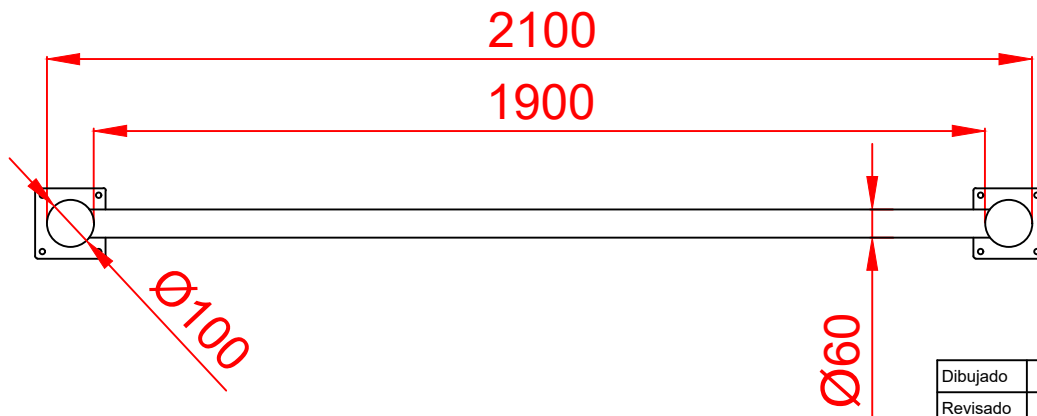

Dibujado		PLANO 1 VISTAS GENERALES		Ref: VLL02-G
Revisado				
Aprobado				
Descripción:		Escala:	Nº Hoja	
VALLA METÁLICA GALVANIZADA Y LACADA			2/3	
		Fecha:	31/07/2019	

PLANTA CIMENTACIÓN  
E: 2/1

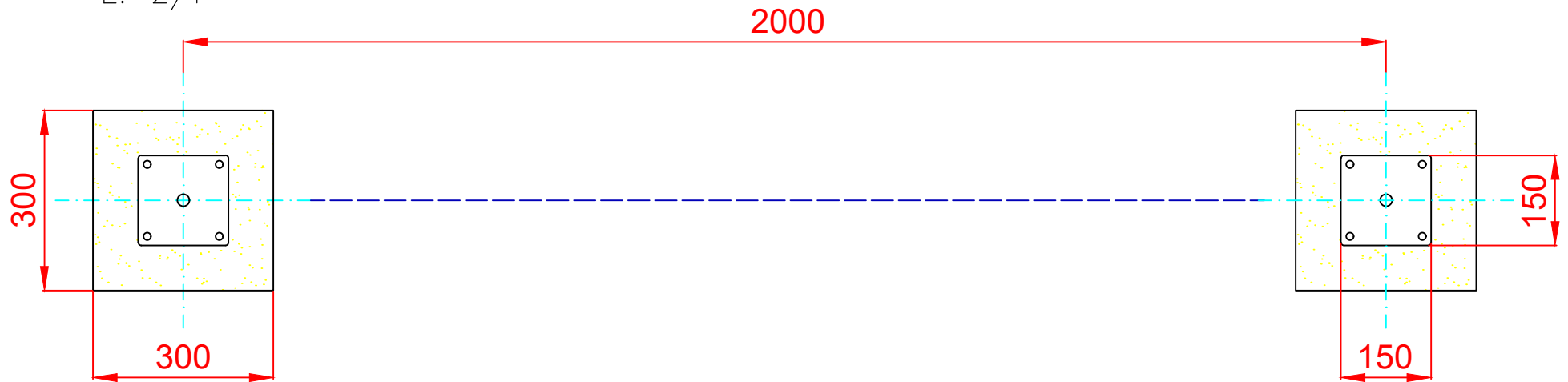

DETALLES CIMENTACIÓN  
ESQUEMA DE CIMENTACIÓN  
EN ARENA

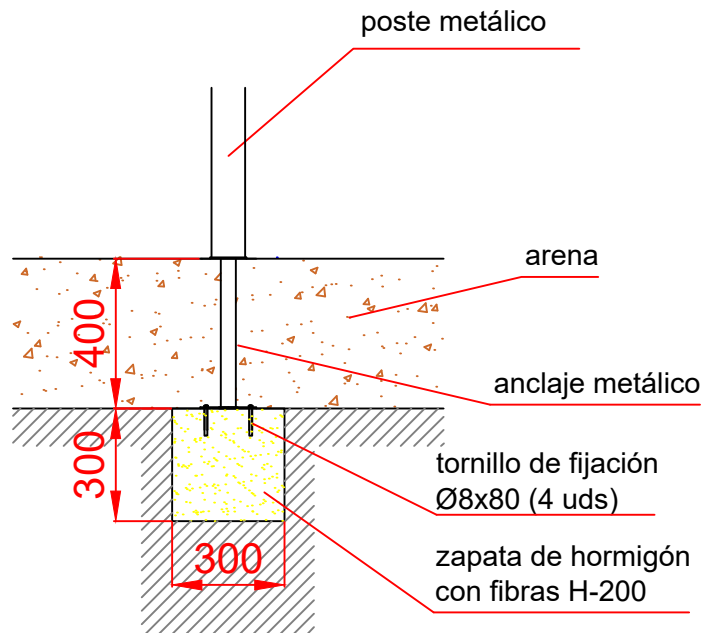

ESQUEMA DE CIMENTACIÓN  
EN HORMIGÓN

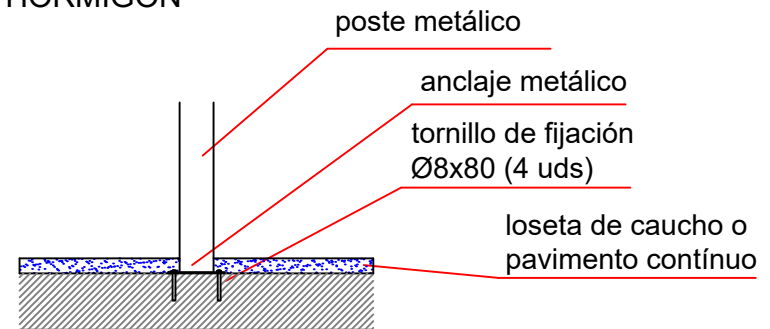

Dibujado		PLANO 2 CIMENTACIÓN Y ANCLAJES		Ref: VLL02-G
Revisado				
Aprobado				
Descripción: VALLA METÁLICA GALVANIZADA Y LACADA		Escala:	Nº Hoja 3/3	
		Fecha: 31/07/2019		